Mathematical Principles in Vision and Graphics: Projective Geometry – Part 3

Ass.Prof. Friedrich Fraundorfer

SS 2019

Learning goals

- Understand the concept of vanishing points and vanishing lines
- Understand the calculation of vanishing points
- Understand the relation between vanishing points and camera orientation and calibration

Outline

- Vanishing points and lines
- Applications of vanishing points

Vanishing points

[Source: Flickr]



Vanishing points

- Ideal points in the projective 3-space are located at infinity, and have homogeneous coordinates of the form $(x, y, z, 0)$.
- These points are also called points at infinity.
- The image of an ideal point under a projective mapping is called a vanishing point.
- Recall that two parallel lines in the projective 3-space meet at an ideal point.
- Thus the images of two or more parallel world lines converge at a vanishing point.



[Source: Flickr]

Vanishing points

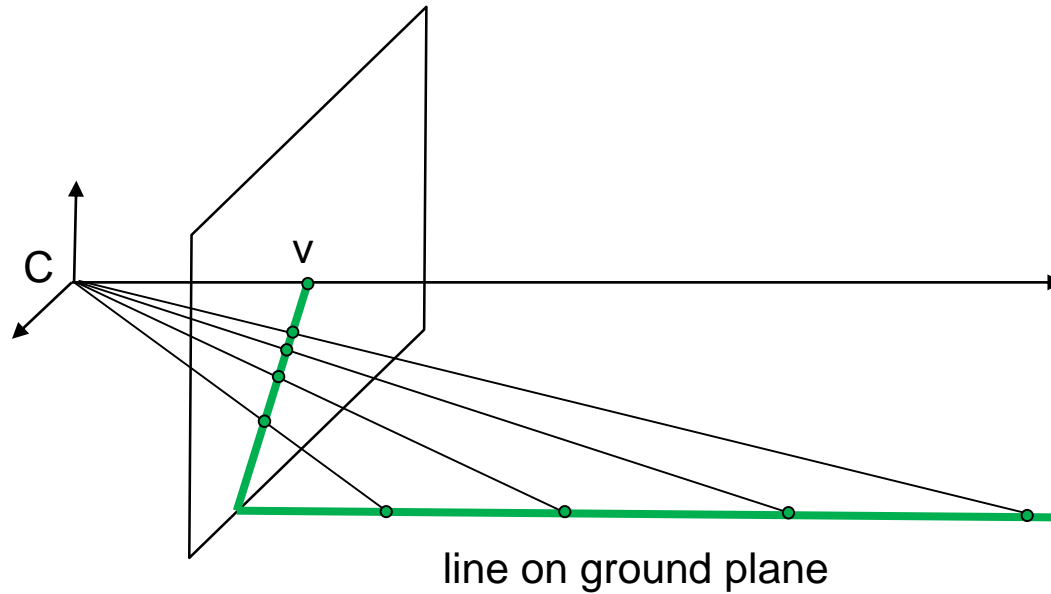

The vanishing point v is the projection of a point at infinity.
Think of extending the line on the ground plane further and further into infinity.

Vanishing points

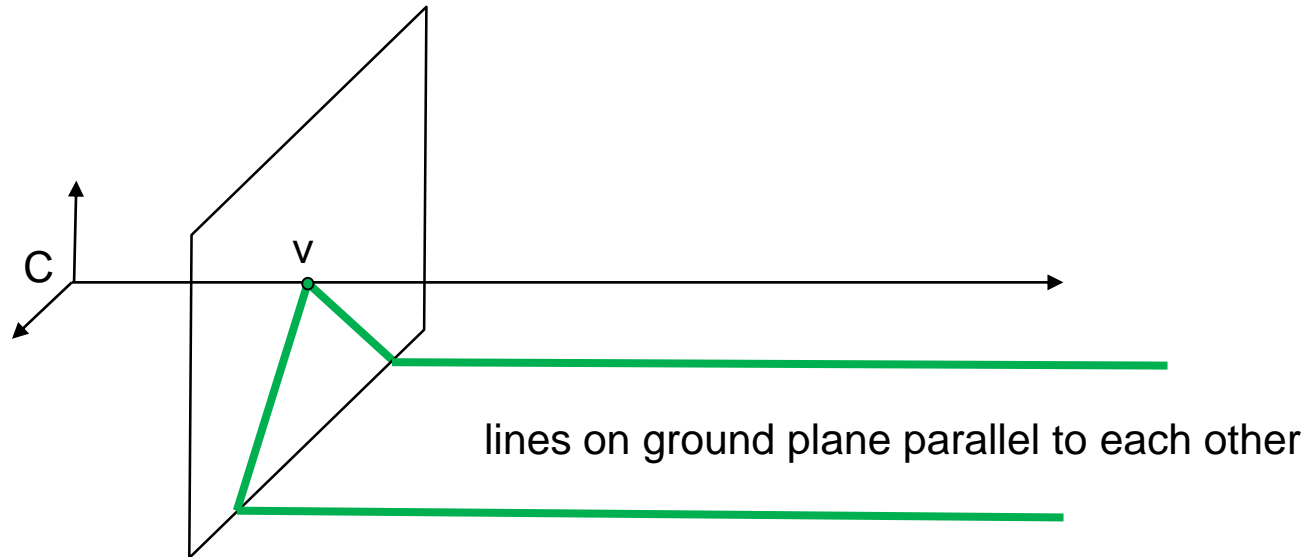

- Any two parallel lines have the same vanishing point v
- The vanishing point is the image of the intersection point of the two parallel lines.
- The ray from C through v is parallel to the lines
- An image may have more than one vanishing point

Vanishing lines

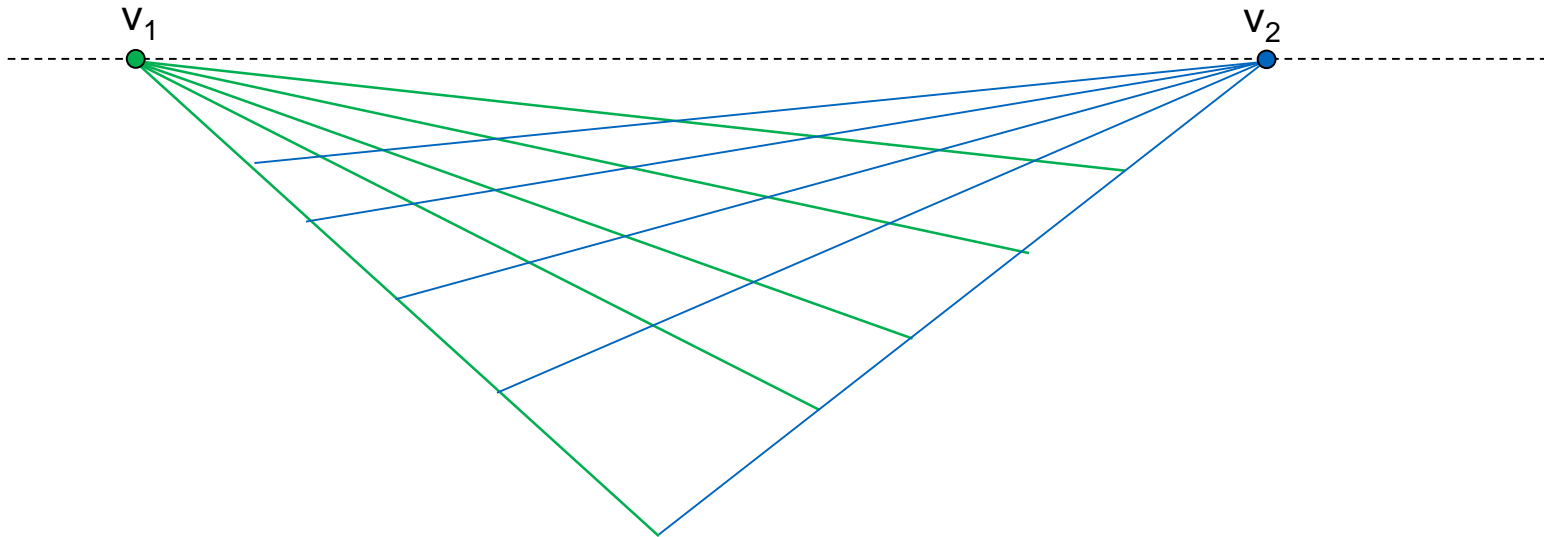

- Multiple vanishing points
 - Any set of parallel lines on the plane define a vanishing point
 - Lines at different orientation result in a different vanishing point
 - The union of all of vanishing points from lines on the same plane is the vanishing line

Vanishing lines

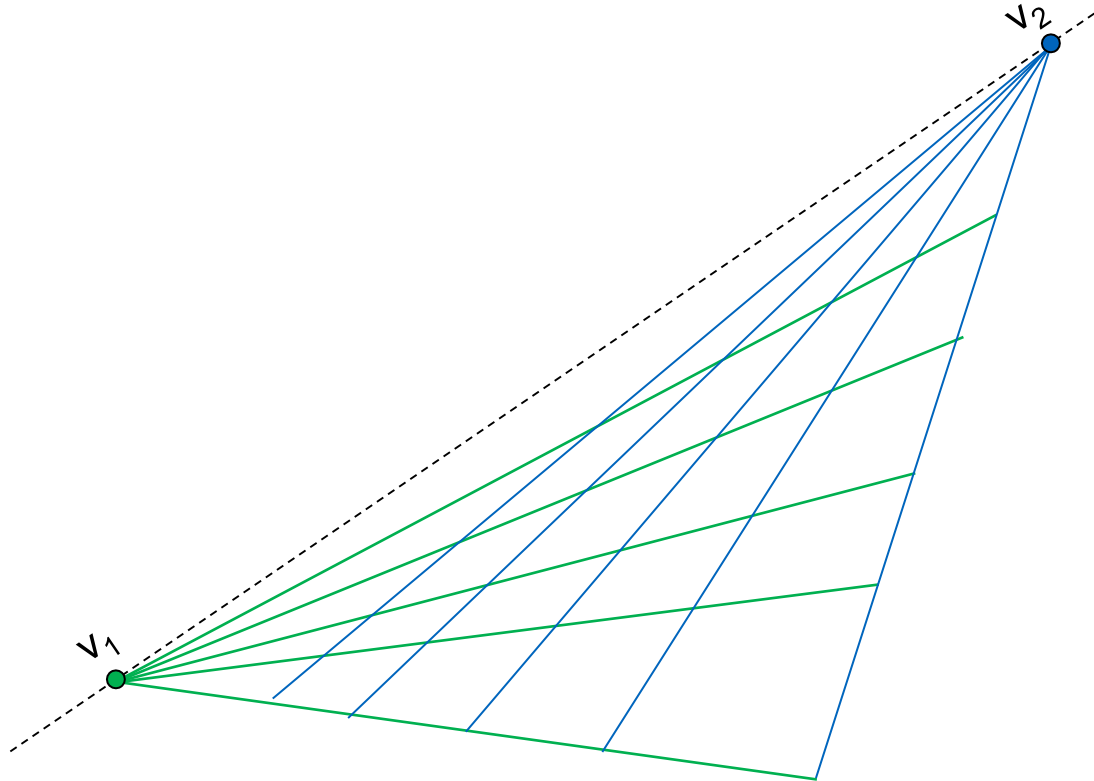

- Different planes define different vanishing lines.

Vanishing lines

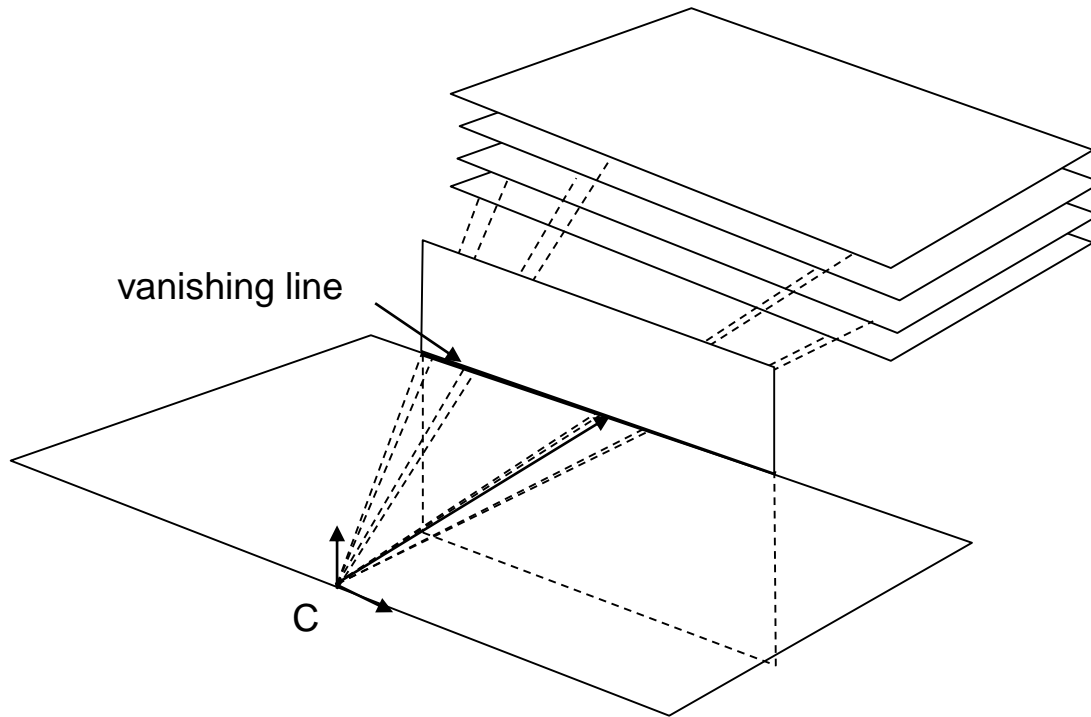

- A set of parallel planes that are not parallel to the image plane intersect the image plane at a vanishing line.
- The horizon is a special vanishing line when the set of parallel planes are parallel to the ground reference.
- Anything in the scene that is above the camera will be projected above the horizon in the image.

Computing vanishing points

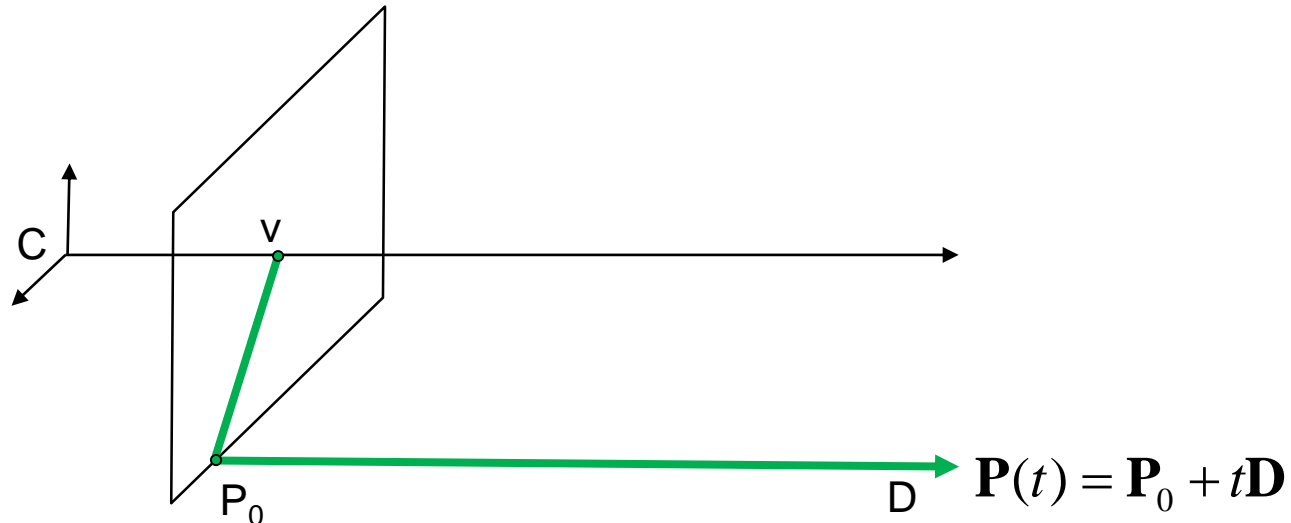

$$\mathbf{P}(t) = \begin{bmatrix} P_X + tD_X \\ P_Y + tD_Y \\ P_Z + tD_Z \\ 1 \end{bmatrix} \cong \begin{bmatrix} P_X / t + D_X \\ P_Y / t + D_Y \\ P_Z / t + D_Z \\ 1/t \end{bmatrix} \quad t \rightarrow \infty \quad \mathbf{P}_\infty \cong \begin{bmatrix} D_X \\ D_Y \\ D_Z \\ 0 \end{bmatrix}$$

- Properties $\mathbf{v} = \mathbf{I}\mathbf{P}_\infty$
 - \mathbf{P}_∞ is a point at infinity, \mathbf{v} is its projection
 - They depend only on line direction
 - Parallel lines $\mathbf{P}_0 + t\mathbf{D}$, $\mathbf{P}_1 + t\mathbf{D}$ intersect at \mathbf{P}_∞

Computing vanishing points (from lines)

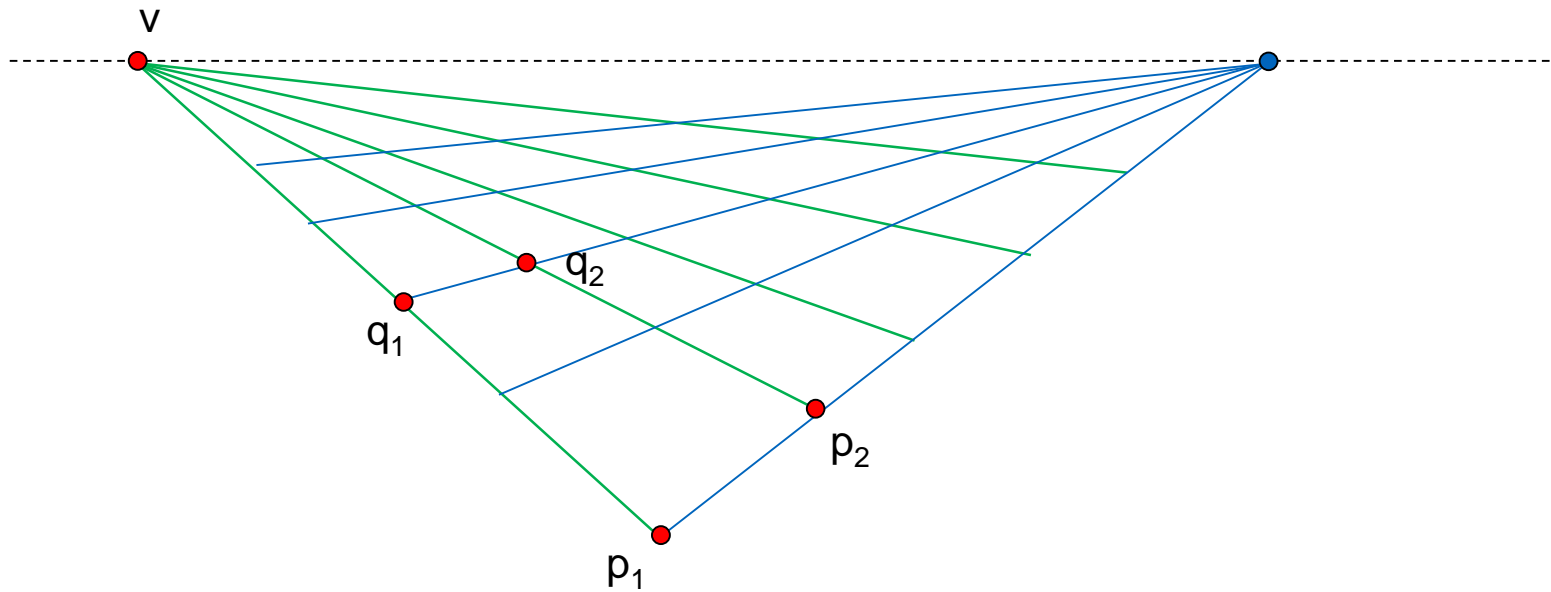

- Intersect p_1q_1 with p_2q_2

$$v = (p_1 \times q_1) \times (p_2 \times q_2)$$

Computing vanishing points by projection

- Let $P = K[I \mid 0]$ be a camera matrix. The vanishing point of lines with direction d in 3-space is the intersection v of the image plane with a ray through camera center with direction d . This vanishing point v is given by $v = Kd$.

$$v = \begin{bmatrix} 1 & 0 & 0 & 0 \\ 0 & 1 & 0 & 0 \\ 0 & 0 & 1 & 0 \end{bmatrix} \begin{bmatrix} D \\ 0 \end{bmatrix} = \begin{bmatrix} D_x \\ D_y \\ D_z \end{bmatrix}$$

- Example: Computing vanishing points of lines on a XZ plane
- (1) parallel to the Z axis, (2) at 45 deg to the Z axis
- (3) parallel to the X axis

$$D_1: \begin{bmatrix} 0 \\ 0 \\ 1 \\ 0 \end{bmatrix} \rightarrow \begin{bmatrix} 0 \\ 0 \\ 1 \end{bmatrix}$$

$$D_2: \begin{bmatrix} 1 \\ 0 \\ 1 \\ 0 \end{bmatrix} \rightarrow \begin{bmatrix} 1 \\ 0 \\ 1 \end{bmatrix}$$

$$D_3: \begin{bmatrix} 1 \\ 0 \\ 0 \\ 0 \end{bmatrix} \rightarrow \begin{bmatrix} 1 \\ 0 \\ 0 \end{bmatrix}$$

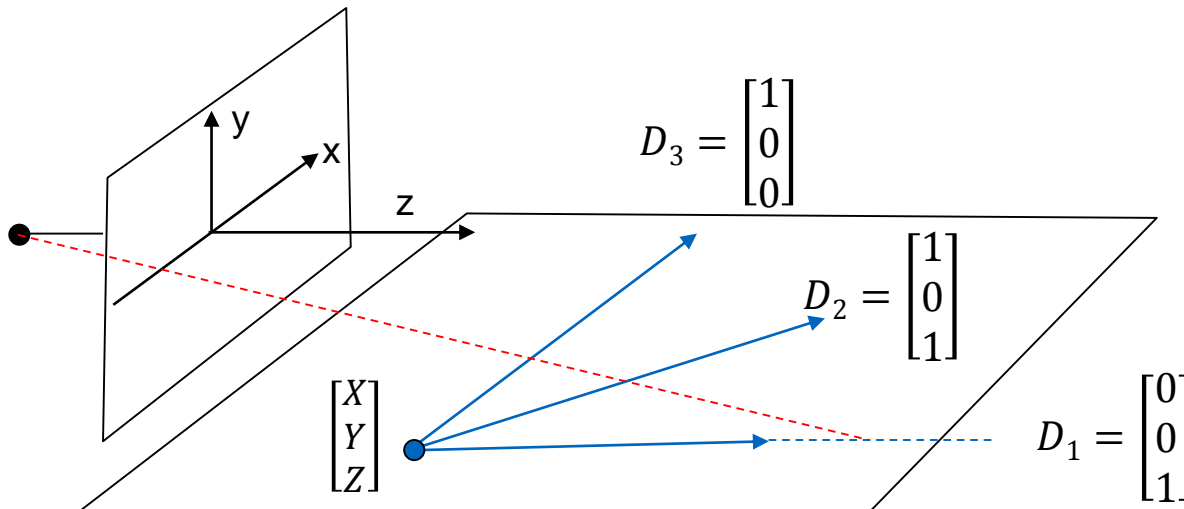

Vanishing points and projection matrix

$$P = \begin{bmatrix} * & * & * & * \\ * & * & * & * \\ * & * & * & * \end{bmatrix} = [p_1 \quad p_2 \quad p_3 \quad p_4]$$

- $p_1 = P[1 \ 0 \ 0 \ 0]^T = v_x$ (X vanishing point)
- similarly, $p_2 = v_y$, $p_3 = v_z$
- $p_4 = P[0 \ 0 \ 0 \ 1]^T =$ projection of world origin O

$$P = [\mathbf{v}_X \quad \mathbf{v}_Y \quad \mathbf{v}_Z \quad \mathbf{o}]$$

Real vanishing points

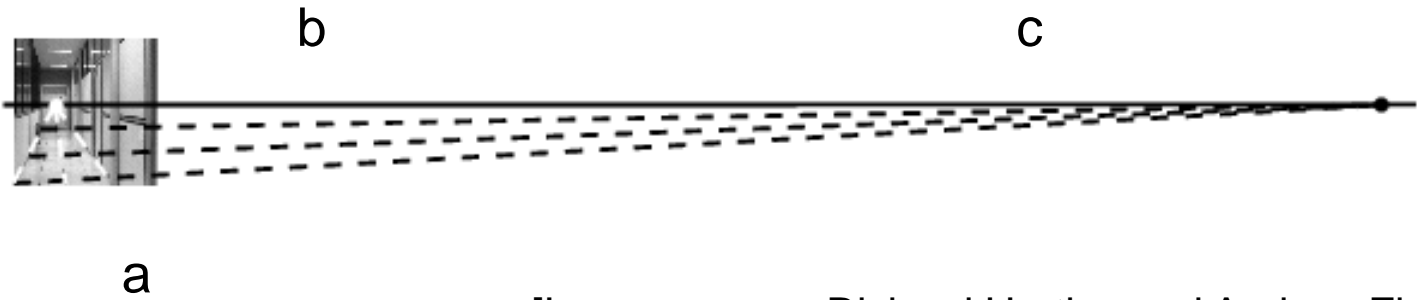

[Image source: Richard Hartley and Andrew Zisserman]

Vanishing point of a line parallel to a plane lies on the vanishing line of the plane

Image rectification using vanishing points



before rectification



after rectification

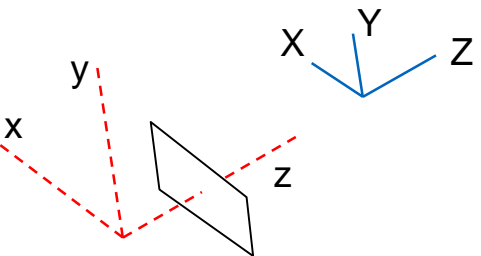
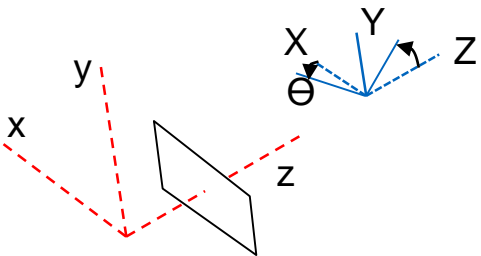

Camera rotation from vanishing points

- Two images of a scene obtained by the same camera from different position and orientation.
- The images of the points at infinity, **the vanishing points**, are not affected by the camera translation, but are affected only by the camera rotation
- Vanishing points v_i and v_i' have the following directions d_i , d_i'

$$d_i = K^{-1}v_i / \|K^{-1}v_i\|$$
$$d_i' = K^{-1}v_i' / \|K^{-1}v_i'\|$$

- The directions are related by a rotation matrix:

$$d_i' = R d_i$$

- If the directions are known, the rotation matrix can be computed from two directions

Camera rotation from vanishing points

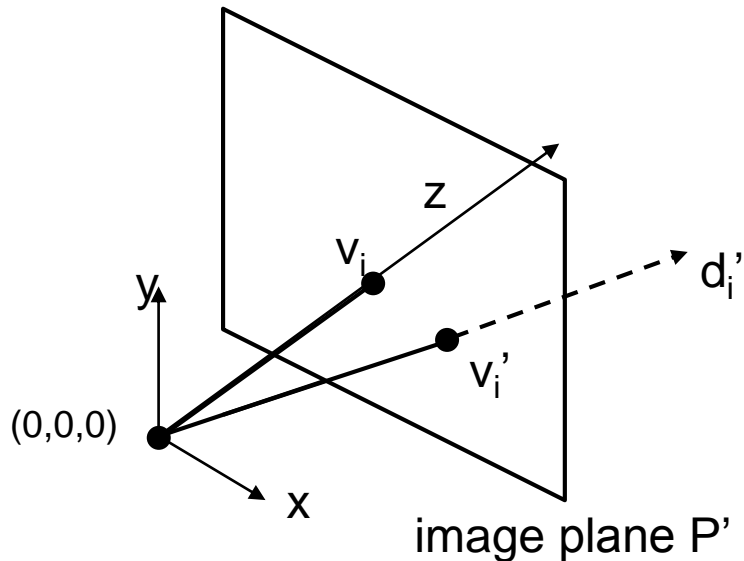

- First camera is aligned with world coordinate system. $d_i = [0 \ 0 \ 1]$
- Second camera deviates, $d_i' = [d_x, d_y, d_z]$ and can be computed from the image coordinates of v_i'
- The rotation that aligns the second image with the first image can be computed from d_i and d_i' and 1 more direction.

Measuring heights using vanishing points

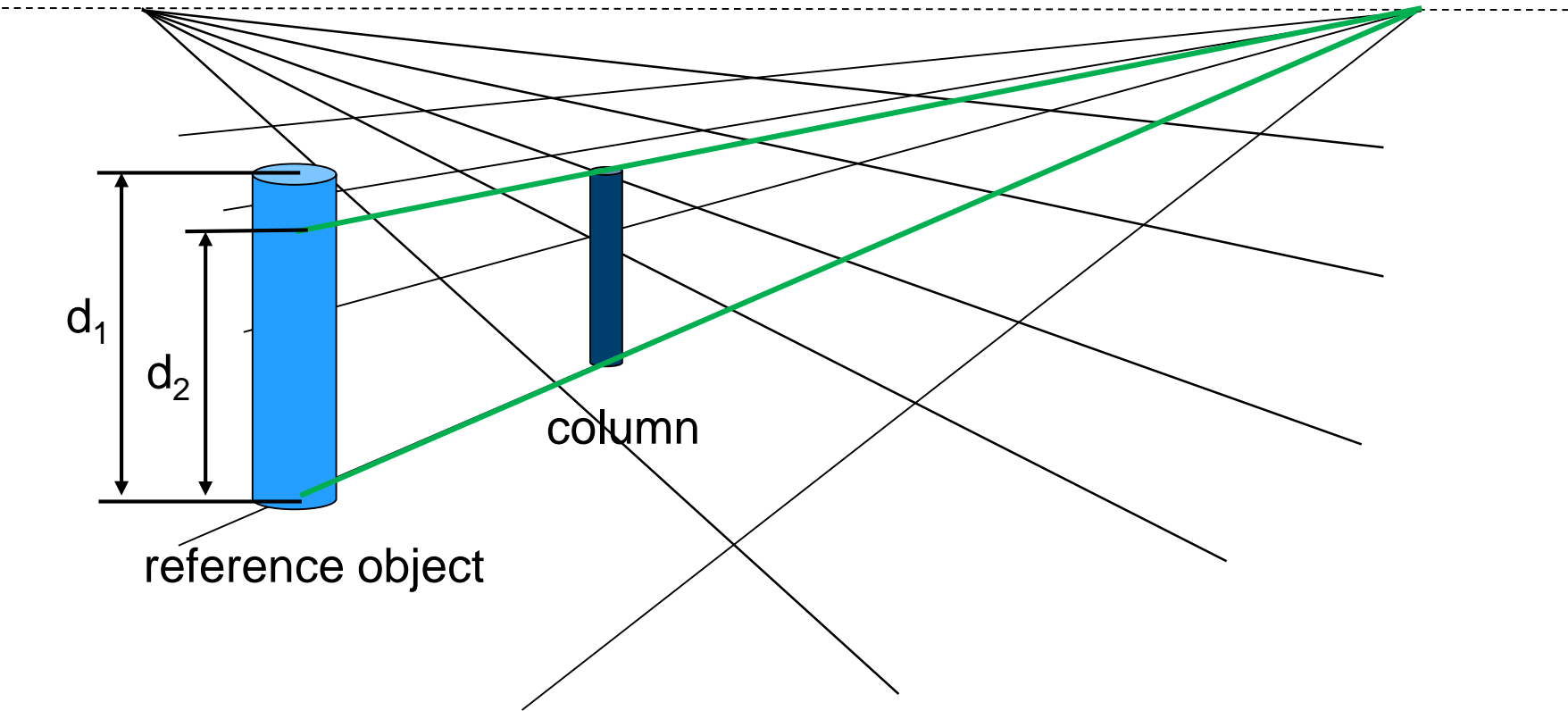

Height column = height of reference object * d_2/d_1

Camera calibration from orthogonal vanishing points

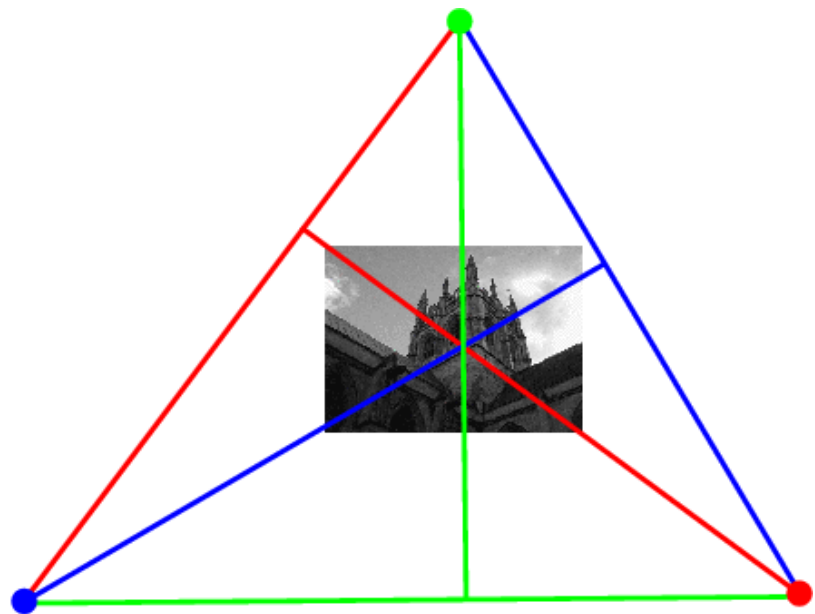

[Image source: Richard Hartley and Andrew Zisserman]

Recap - Learning goals

- Understand the concept of vanishing points and vanishing lines
- Understand the calculation of vanishing points
- Understand the relation between vanishing points and camera orientation and calibration